

卫生型高弹橡胶-无缝过程连接



适用范围

- 卫生型高弹橡胶且无缝过程连接，适用于酿酒，牛奶，食品和药厂以及生物工艺学和外围设备应用（水-污水处理等）

功能原理

- 传感器的锥体是通过传感器螺纹连接用定力压向安装件密封角的（如下图所示）
- 因此，不用任何高弹橡胶密封材料即可实现无缝完美的卫生应用，且取得了EHEDG证明以及3A认证。

卫生型设计

- 高弹橡胶-无缝安装通过了EHEDG和3A认证

特性

- 电缆入口位置已定。
- 对所有的传感器有三种接头尺寸（M12；G1/2"；G1"）
- 标准组件适用于所有已建立的过程连接：TriClamp, Dairy flange, DRD, Varivent, APV-Inline, BioControl, vibration switch adapter, SMS, RJT, IDF, flanges依据DIN和ISO

NEGELE高弹橡胶和无缝密封系统图表描述

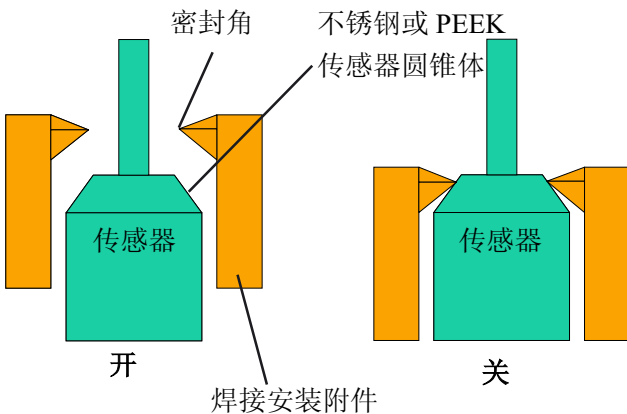

金属密封（PEEK）



金属密封（金属）



特性

过程连接	接头 转矩	M12; G1/2" ; G1" 见第 4 页的表格
材质	选项 要求	SS (316L) 2.2 认证 3.1.B 认证
温度	密封金属-金属	最高 250° C
	密封金属-金属	最高 150° C
压力	密封金属-金属	最大 50bar
	密封金属-金属	最大 10bar
温度	密封金属-金属	最高 250° C
	密封金属-金属	最高 150° C

注意：要使用 Negele 的焊接系统，以确保测量点可靠。

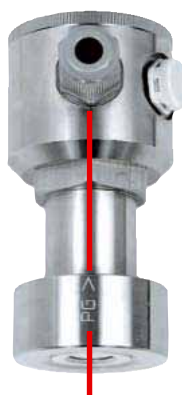







已定义电缆
入口位置



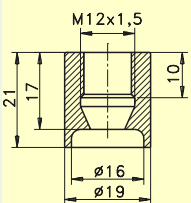

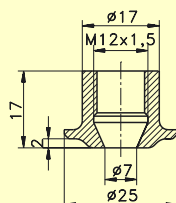

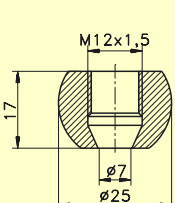

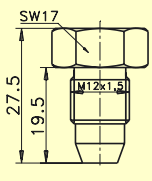

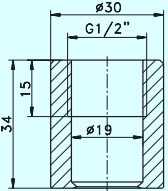

EHG 安装系统
用于管道上的轨道焊接

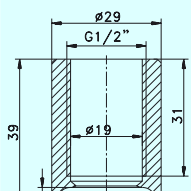
圆柱形 焊接安装件	圆柱形安装件 带焊接圈	圆柱形安装件 带控制孔	环形焊接安装 件	焊接球	仿真法兰 BST
--------------	----------------	----------------	-------------	-----	-------------

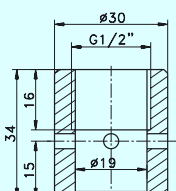

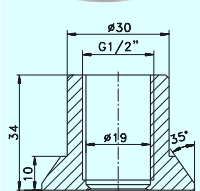

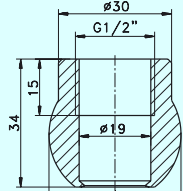

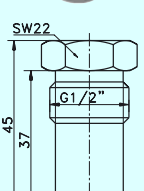
过程连接 M12 卫生型

无	用于支管道 安装	无	用于罐体 厚/薄壁	用于斜面安装	关闭现有的测 量点
	 		 	 	 
	EMS-032		EMK-032	KEM-032	BST-030

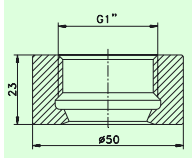
过程连接 G1/2" 卫生型

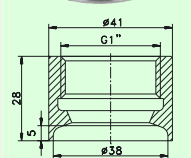
用于罐体	用于支管道 安装	用于罐体带泄 漏探测	用于罐体 厚壁	用于斜面安装	关闭现有的测 量点
 	 	 	 	 	 
EMZ-132	EMS-132	EMZ-131	EMK-132	KEM-132	BST-130

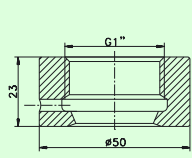
过程连接 G1" 卫生型

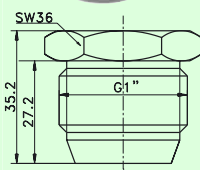
用于罐体 厚/薄	用于支管道 安装	用于罐体带泄 漏探测	无	无	关闭现有的测 量点
 	 	 			 
EMZ-352	EMS-352	EMZ-351			BST-350

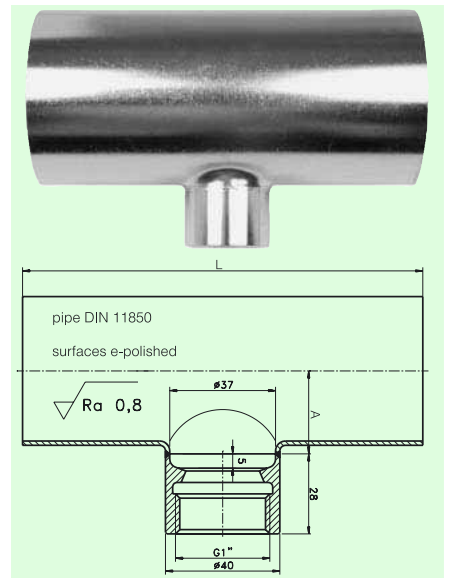
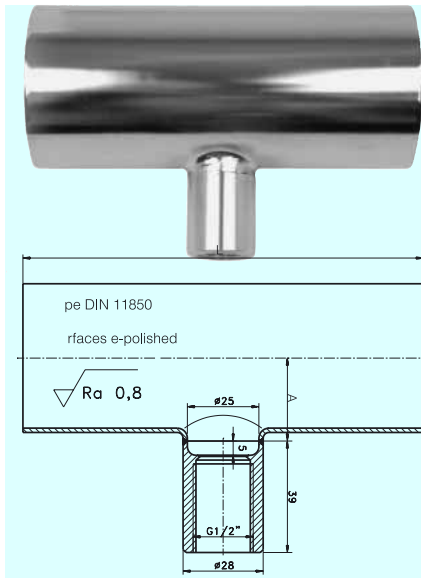
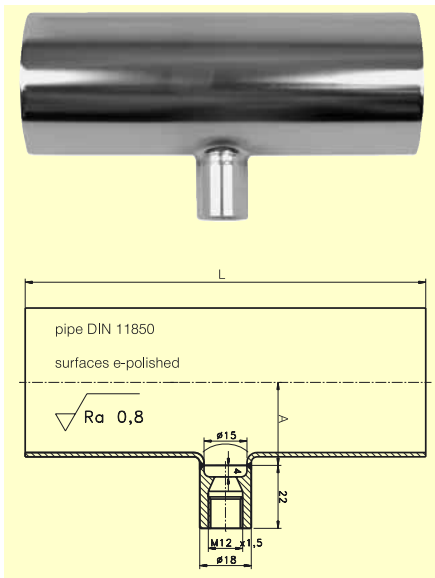

EHG-.../M12 尺寸表

型号	DN	L [mm]	A [mm]
EHG-15/M12	15	70	10
EHG-25/M12	25	100	15
EHG-40/M12	40	120	22
EHG-50/M12	50	140	29
EHG-65/M12	65	160	38
EHG-80/M12	80	180	46

EHG-.../1/2" 尺寸表

型号	DN	L [mm]	A [mm]
EHG-25/1/2"	25	100	15
EHG-40/1/2"	40	120	22
EHG-50/1/2"	50	140	29
EHG-65/1/2"	65	160	38
EHG-80/1/2"	80	180	46

EHG-.../1" 尺寸表

型号	DN	L [mm]	A [mm]
EHG-40/1"	40	120	22
EHG-50/1"	50	140	29
EHG-65/1"	65	160	38
EHG-80/1"	80	180	46

焊接和安装说明

焊接到容器上

请使用 Negele 安装附件，
EMZ-...;EMK-...或 KEM-...

最大公差: +0.2mm

- 4 点固定安装件 (见图 1)
- 调整焊接心轴
- 焊接两点之间的部分 (见图 2)

如果是 M12 或 G1/2" , 分 4 段
如果是 G1" , 分 8 段

注意: 为防止安装件变形, 在焊完一段后应根据安装件的需要冷却一段时间再焊下一段。

焊接到管道上

请使用 Negele 安装件:
EMZ-...KEM-...
如果是突出管道用 EMS...

- 钻一个安装附件外径大的孔, 最大公差: +0.2mm
- 有 4 点固定安装件 (见图 1)
- 调整焊接心轴
- 焊接两点之间的部分 (见图 2)

如果是 M12 或 G1/2" , 分 4 段
如果是 G1" , 分 8 段

图 1



图 2



图 3

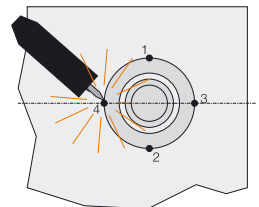

订货举例

焊接心轴 G1/2"

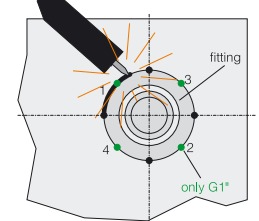
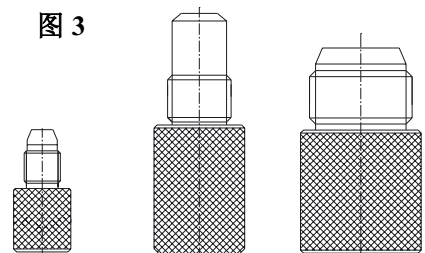
ESD-130

M12 x 1.5
ESD-030

G1/2"
ESD-130

















G1
ESD-350



转矩表

接头尺寸	密封系统	最小转矩 [Nm]	最大转矩 [Nm]
M12×1.5	PEEK	5	10
M12×1.5	VA	5	10
G1/2"	PEEK	5	10
G1/2"	VA	5	20
G1"	PEEK	10	20
G1"	VA	10	20

过程连接一览表

接头尺寸	TriClamp	Diary flange	DRD (压环可选)	Varivent	APV-Inline	BioControl	振动开关 适配器
M12 适配器 直径							
DN10	AMC-032/10	无	无	—	—	无	无
DN15	AMC-032/10			—	—		
DN25	—			AMV-032/25	—		
DN40	—			AMV-032/40	AMA-032		
DN50	—			AMV-032/40	AMA-032		
DN65	—			AMV-032/40	AMA-032		
DN80	—			AMV-032/40	AMA-032		
DN100	—			AMV-032/100	AMA-032		
G1/2" 适配器							
直径							
DN25	AMC-132/1" -1.5"	AMK-132/25	AMK-132/50	AMV-132/25	—	—	AMG-132
DN40	AMC-132/1" -1.5"	AMK-132/40	(仅一个尺寸)	AMV-132/40	AMA-132	AMB-50/1/2"	
DN50	AMC-132/2"	AMK-132/50		AMV-132/40	AMA-132	和	
DN65	AMC-132/3"	AMK-132/65		AMV-132/40	AMA-132	AMB-65/1/2"	
DN80	AMC-132/80	AMK-132/80		AMV-132/40	AMA-132	从 DN40 到	
DN100	AMC-132/4"	AMK-132/100		AMV-132/100	AMA-132	DN100	
G1" 适配器							
直径							
DN25	AMC-352/1" -1.5"		AMK-352/50	—	—	—	无
DN40	AMC-352/1" -1.5"	AMK-352/40	(仅一个尺寸)	AMV-352/40	AMA-352	AMB-352/50	
DN50	AMC-352/2"	AMK-352/50		AMV-352/40	AMA-352	和	
DN65	AMC-352/3"	AMK-352/65		AMV-352/40	AMA-352	AMB-352/65	
DN80	AMC-352/80	AMK-352/80		AMV-352/40	AMA-352	从 DN40 到	
DN100	AMC-352/4"	AMK-352/100		AMV-352/100	AMA-352	DN100	
订货举例:	适配器:G1" 到 APV-Inline DN100:			AMA-352			

根据需要可提供其它过程连接: sms, RJT, IDF, flanges acc. to DIN 和 ISO